

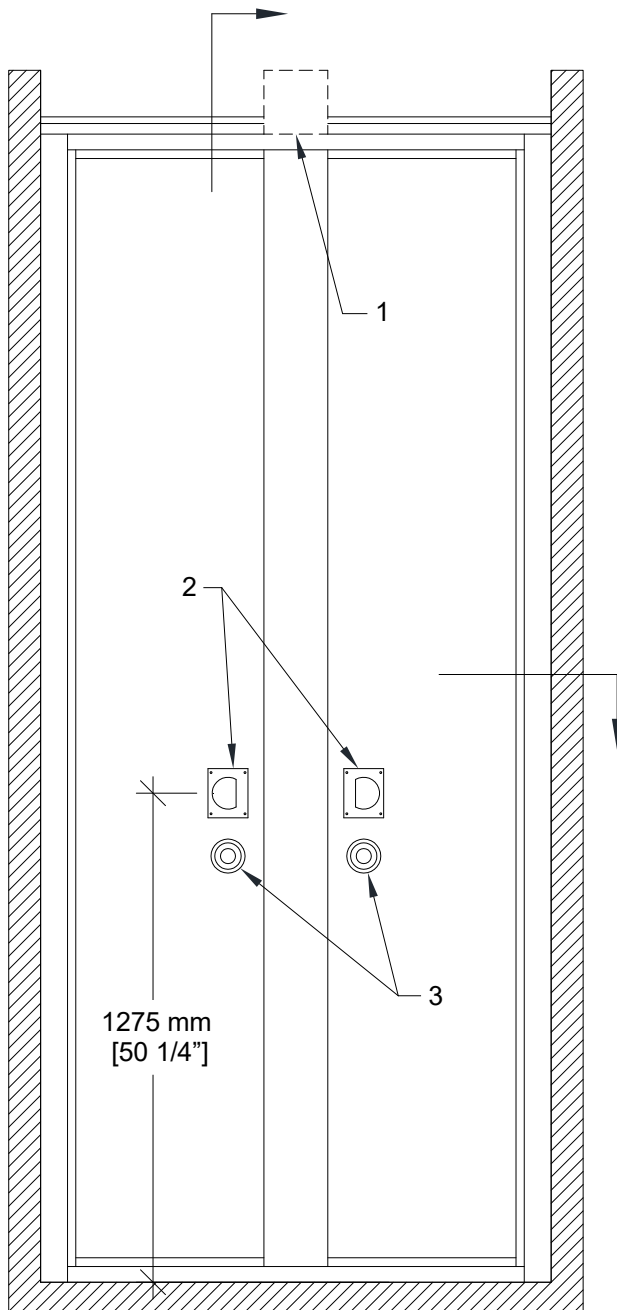

MODERCO

Signature 800 Series

Technical Data Sheet Signature 800 PA-83 Pocket Door



PA-83 Acoustical Pocket Door

- 2 independent sections and 1 center flap
- Same core construction as movable partition panels
- Same surface finish as movable partition / optional custom finish / unfinished
- Same frame finish as movable partition / optional custom finish
- Fixed top, bottom and vertical sweeps
- Top and bottom locking bolts
- Low profile hinges

1- Track

2- Flush pulls

3- Top and bottom locking bolt activator

Vertical Section

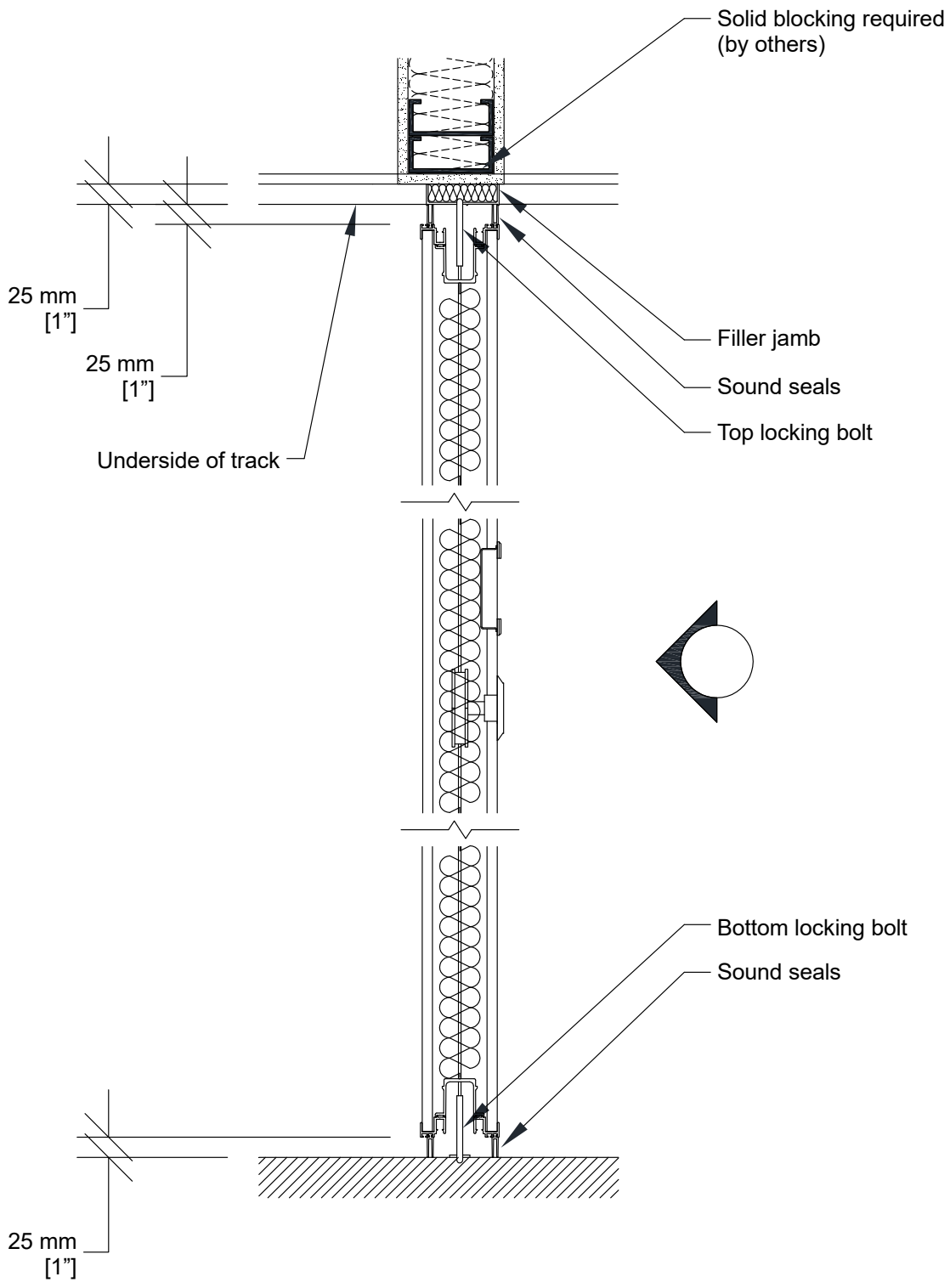

Horizontal Section

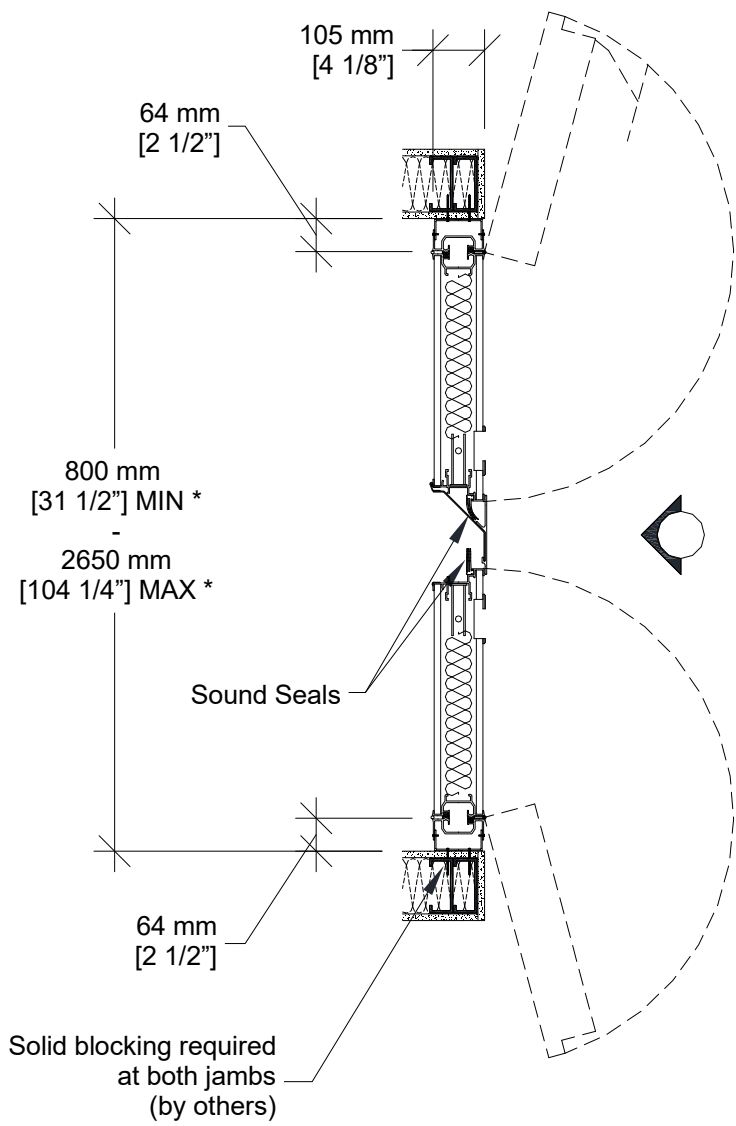

* Min/Max dimensions are fabrication limits and do not account for job-specific conditions.

Please consult shop drawings or local Moderco distributor prior to sizing pockets.