

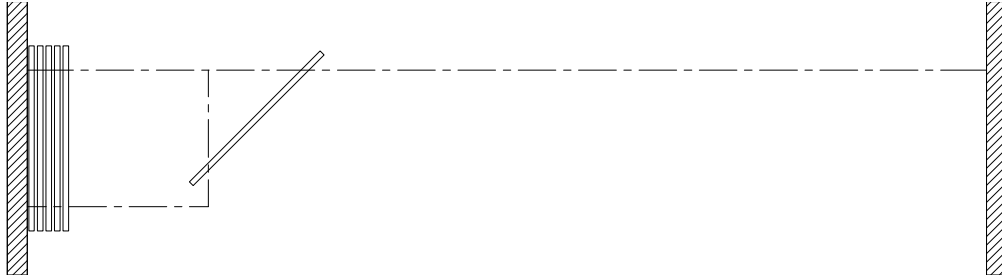

MODERCO

VISION 100 Series

Technical Data Sheet Vision 121



Features & Options

Standard Features

- Manually-operated individual-panel glass movable partition.
- 35 mm [1 3/8"] nominal thickness. Up to 1220 mm [48"] width.
- Clear 12 mm [1/2"] tempered glass faces with polished vertical edges.
- Clear anodized aluminum horizontal mouldings with brush seals.
- Each panel fitted with a foot bolt to stabilize the partition.
- Clear anodized 6063-T6 alloy aluminum track.
- Each panel supported by two dual horizontal wheel carriers with nylon tires over hardened precision ground steel ball bearing wheels.
- Maximum height : 3658 mm [12'-0"].

Optional Features and Accessories

- Powder-coated horizontal mouldings and/or track.
- Glass finishes : stained, colored, acid washed, frosted, etc.

- 11 ga. steel track with programmable switches, painted white.
- Floor bolt lock, one side.
- Deadbolt floor lock with
 - thumb turn cylinder, one side;
 - keyed and thumb turn cylinders;
 - keyed cylinder, one side;
 - keyed cylinders, both sides.
- Final closure by 305 mm [12"] pivot panel.
- Final closure by 305 mm [12"] flap panel.
- Final closure by ADA-compliant pivot door. Optional pivot door hardware:
 - Floor-concealed door closer.
 - Keyed lock and thumb turn.
 - Keyed lock both sides.
 - Deadbolt floor lock with:
 - thumb turn cylinder, one side;
 - keyed and thumb turn cylinders;
 - keyed cylinder, one side;
 - keyed cylinders, both sides.
 - Panic bar (with lockable lever on opposite side).
 - Architectural pulls.
- Full-height pass through door. Optional door hardware:
 - Keyed lock and thumb turn.
 - Keyed lock both sides.
 - Self-closing hydraulic hinges

Vertical Section

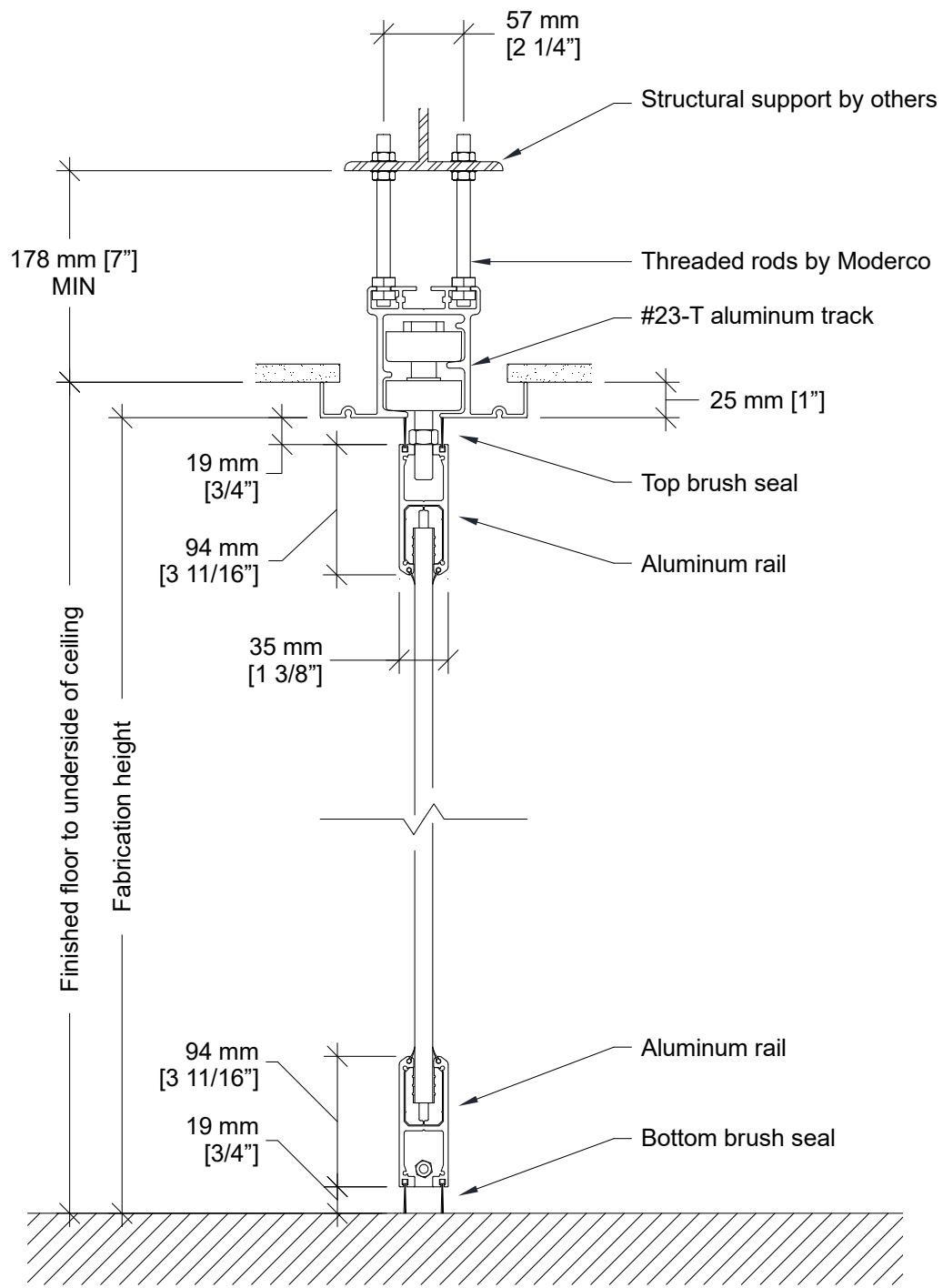

Track Options

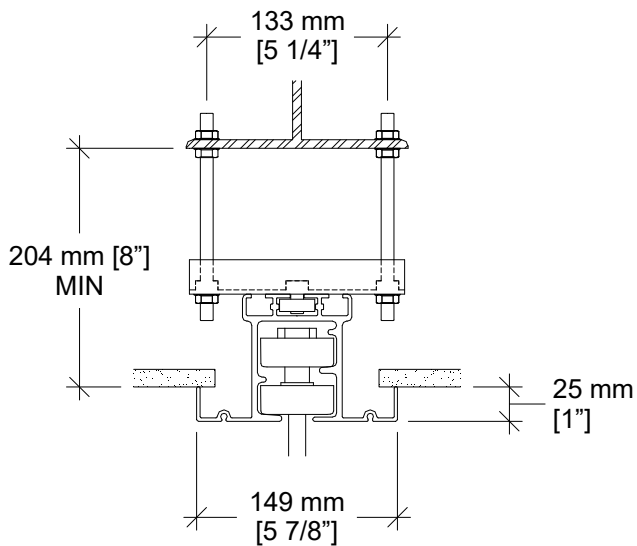

Optional Hanger Bracket

Required for installations where the topmost nuts cannot be used for adjustment.

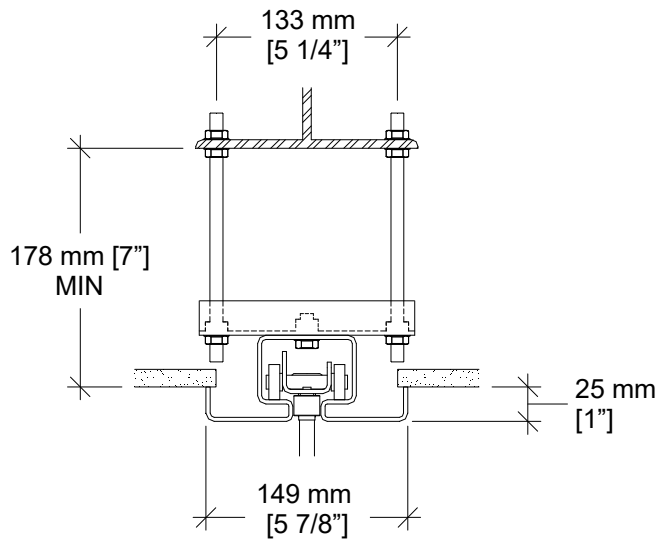

#72 steel track with hanger bracket

Programmable switches.

Requires pivot door.

Elevations

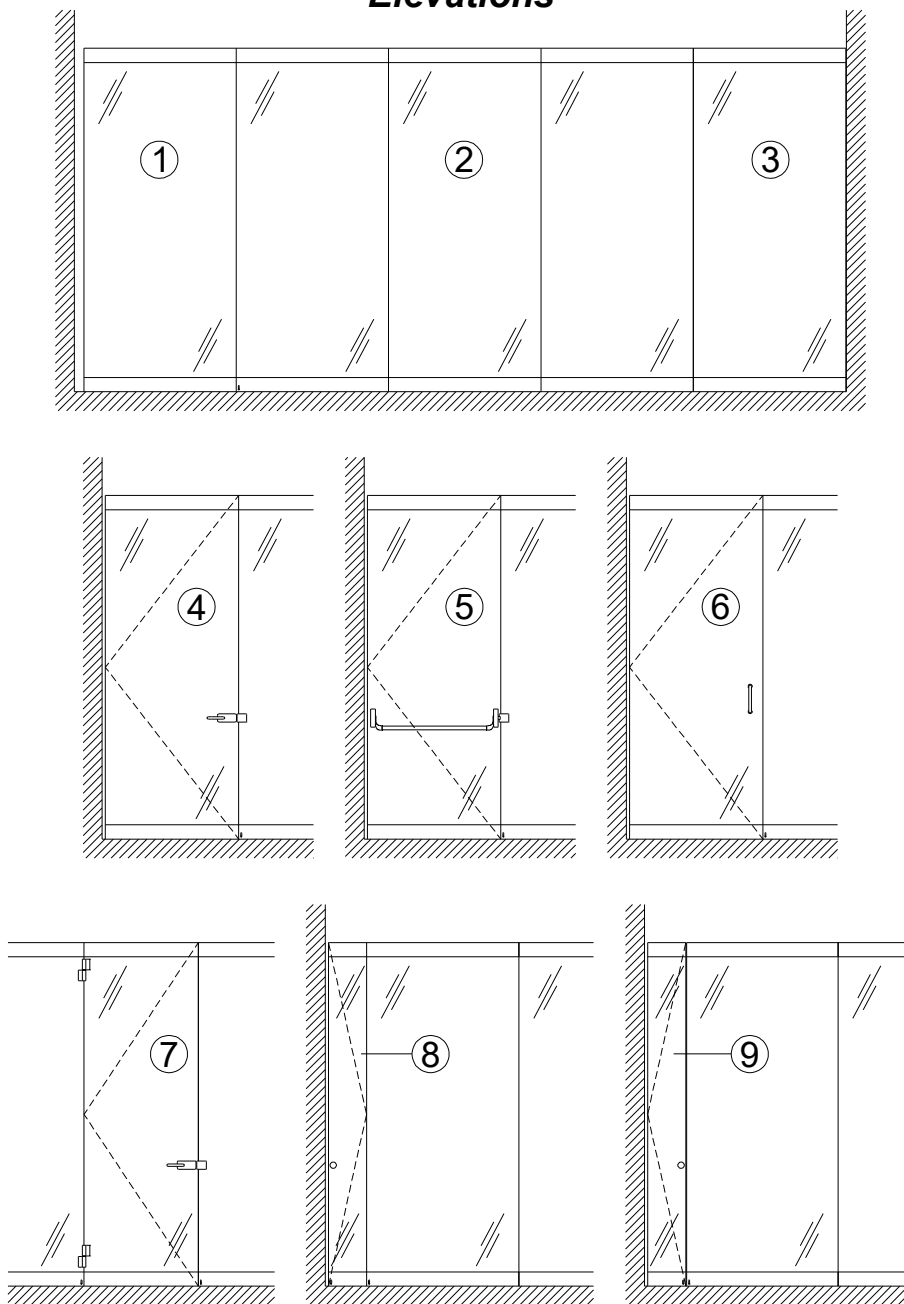

- 1- Trail panel
- 2- Intermediate panel
- 3- Lead panel
- 4- Optional Pivot door
- 5- Optional Pivot door with panic bar (and lockable lever on opposite side)
- 6- Optional Pivot door with architectural pulls
- 7- Optional Full-height door
- 8- Optional Flap closure panel
- 9- Optional Pivot closure panel

Plan Views

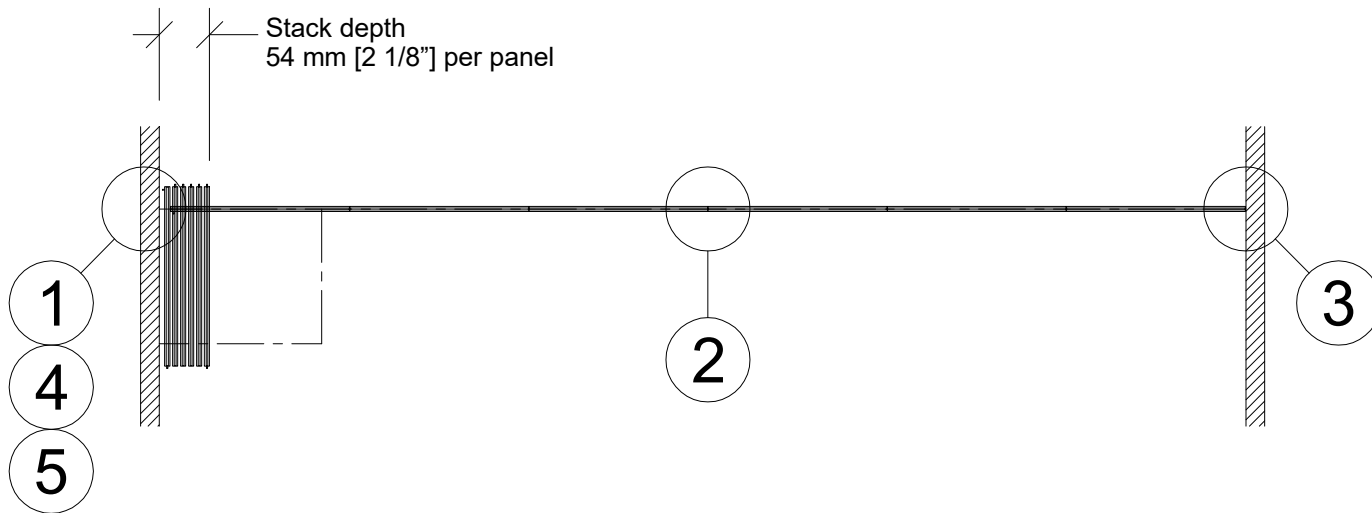

Wall to wall layout

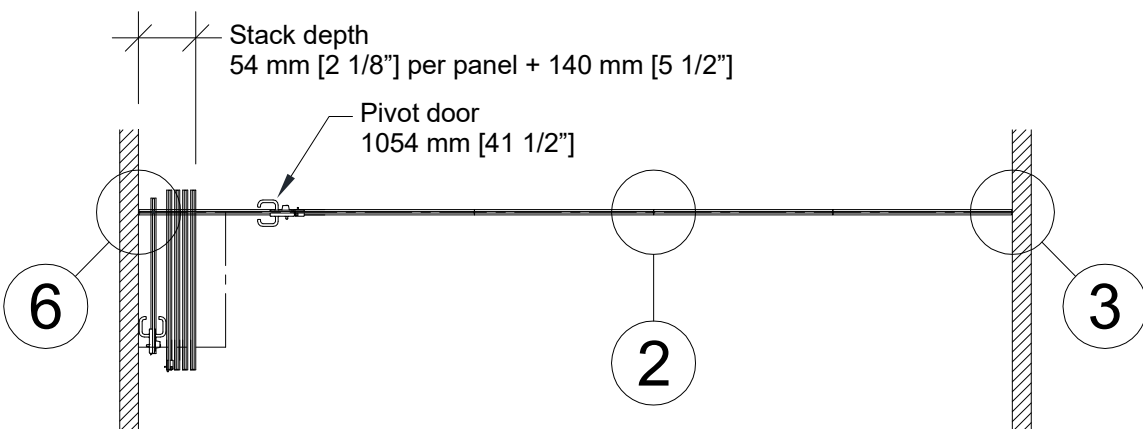

Pivot door

Horizontal Sections

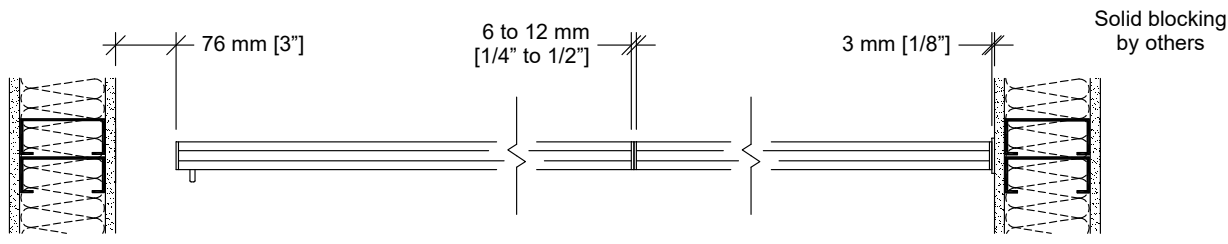

1 Trail end

2 Panel joint

3 Lead end

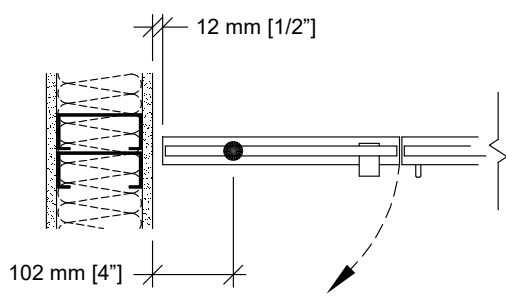

4 Optional pivot closure panel

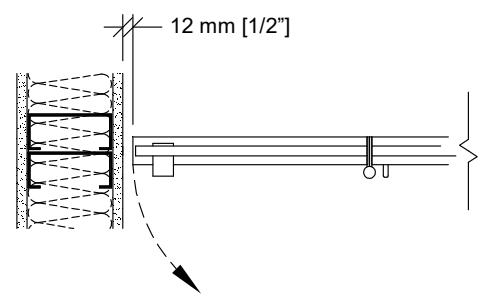

5 Optional flap closure panel

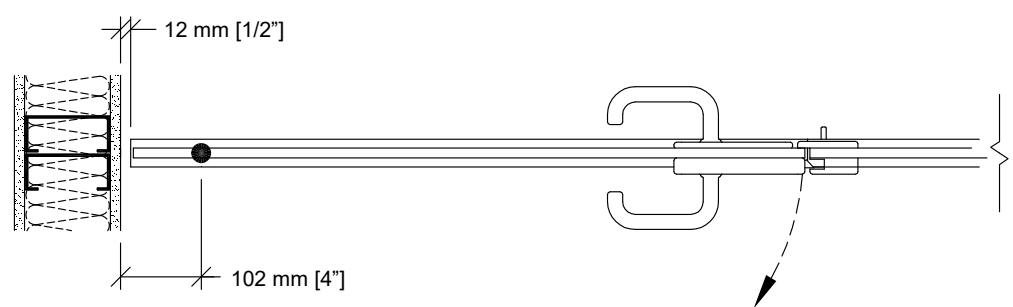

6 Optional pivot door

Floor Bolts

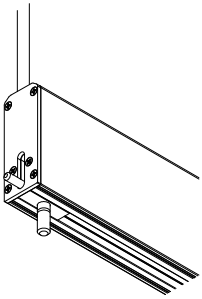

Edge-activated floor bolt.

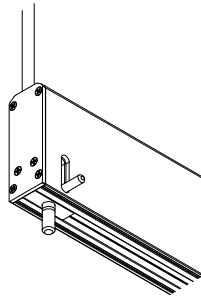

Face-activated floor bolt.

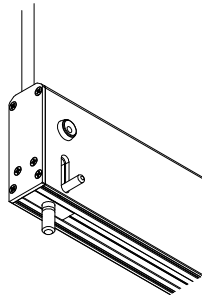

Floor bolt lock.

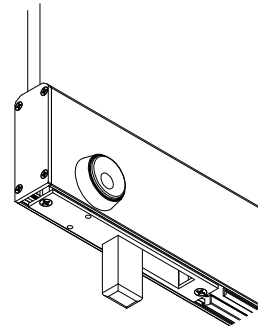

Deadbolt floor lock with keyed cylinder.

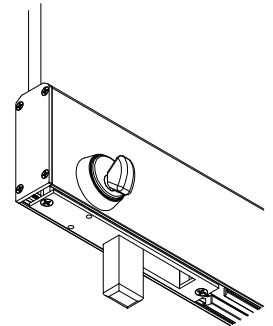

Deadbolt floor lock with thumb turn.

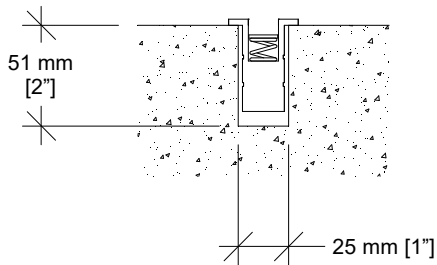
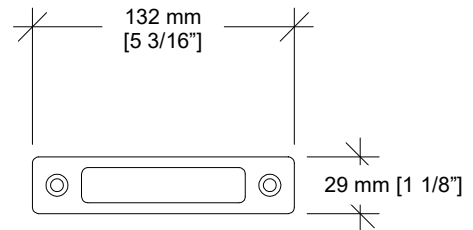
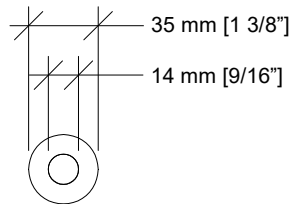

Dust-proof strike for floor bolt.

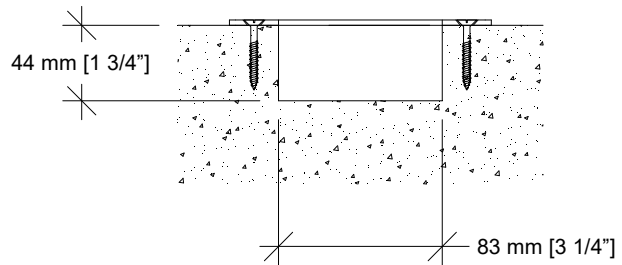

Strike for deadbolt floor lock.

Typical Layouts - #23-T Track

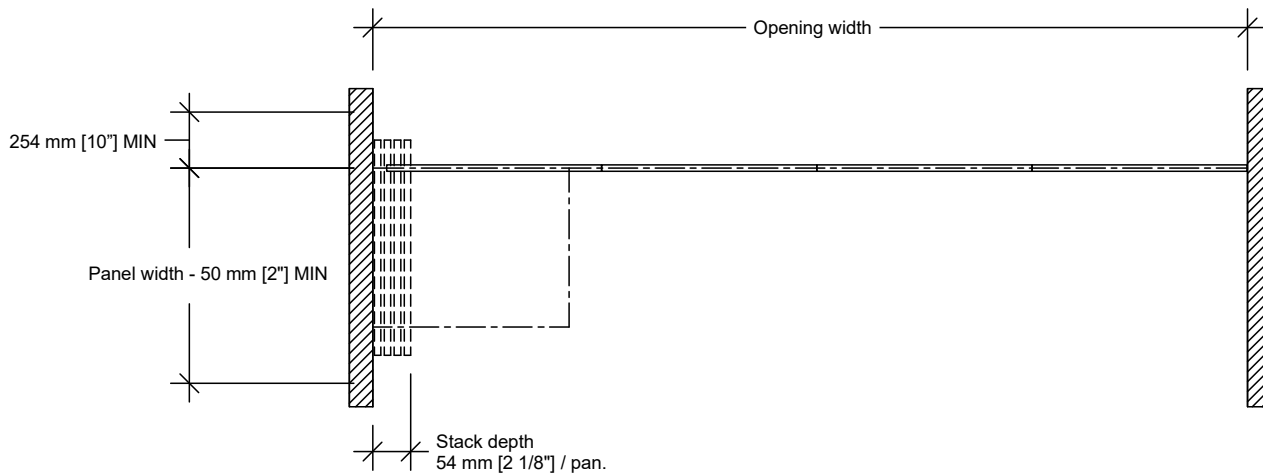

Wall to wall Side Stack

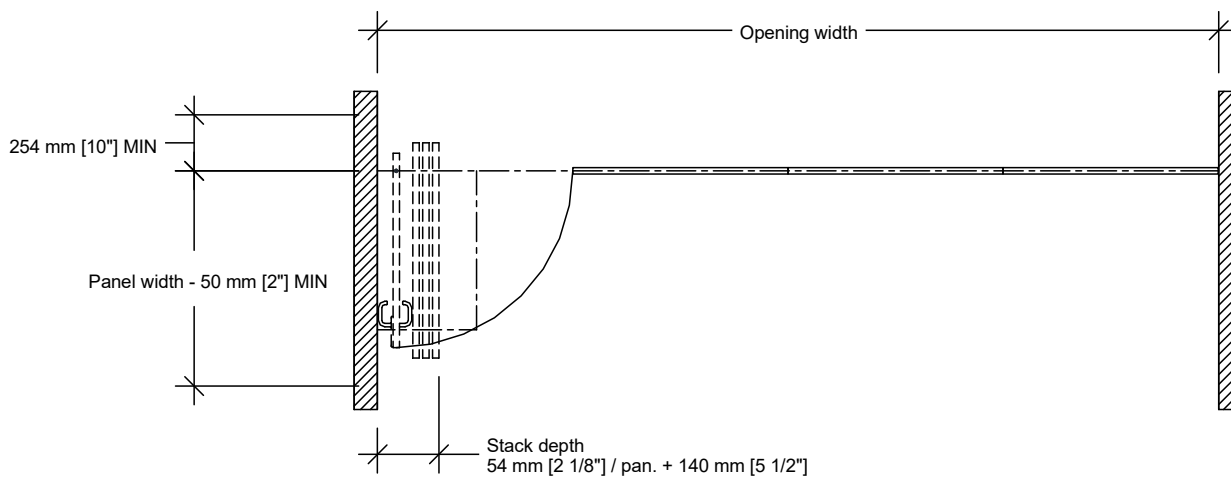

Wall to wall Side Stack – pivot door

Typical Layouts - #23-T Track (cont'd)

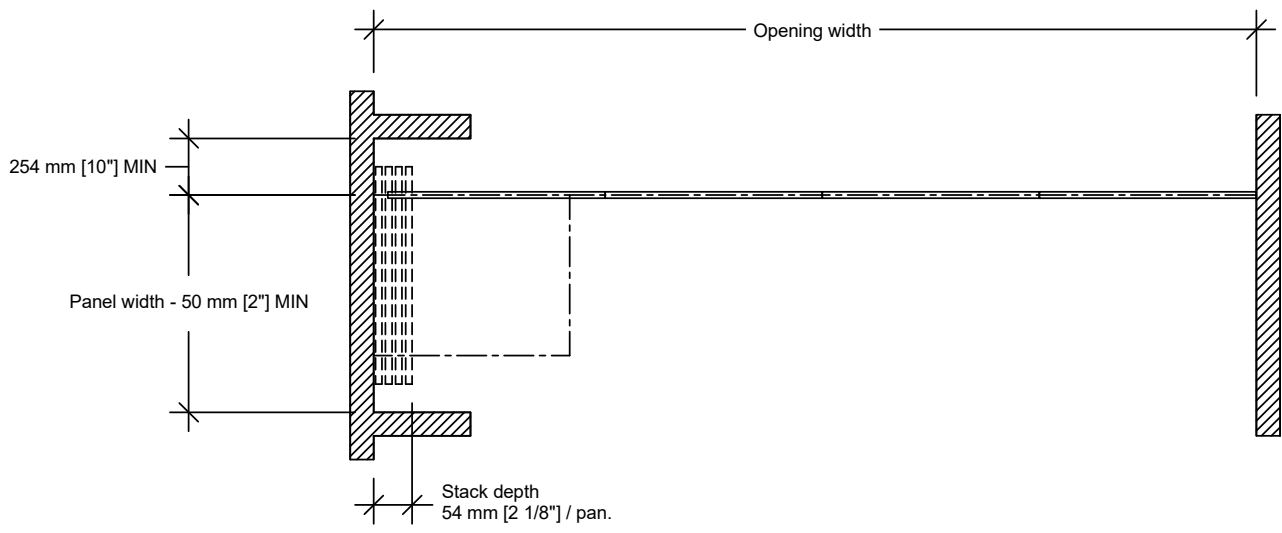

Pocket

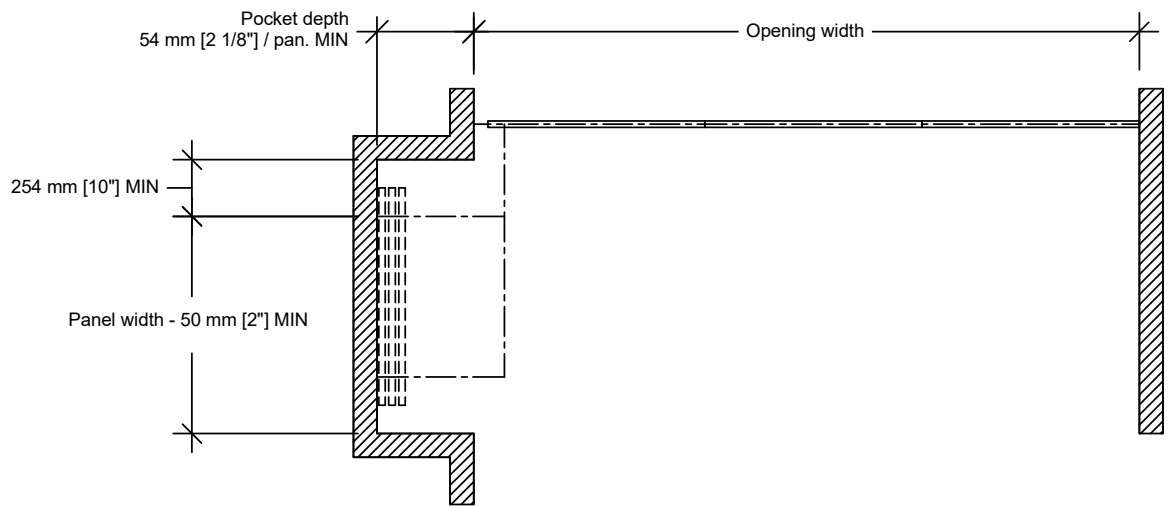

Remote Stack



Typical Layout - #72 Track

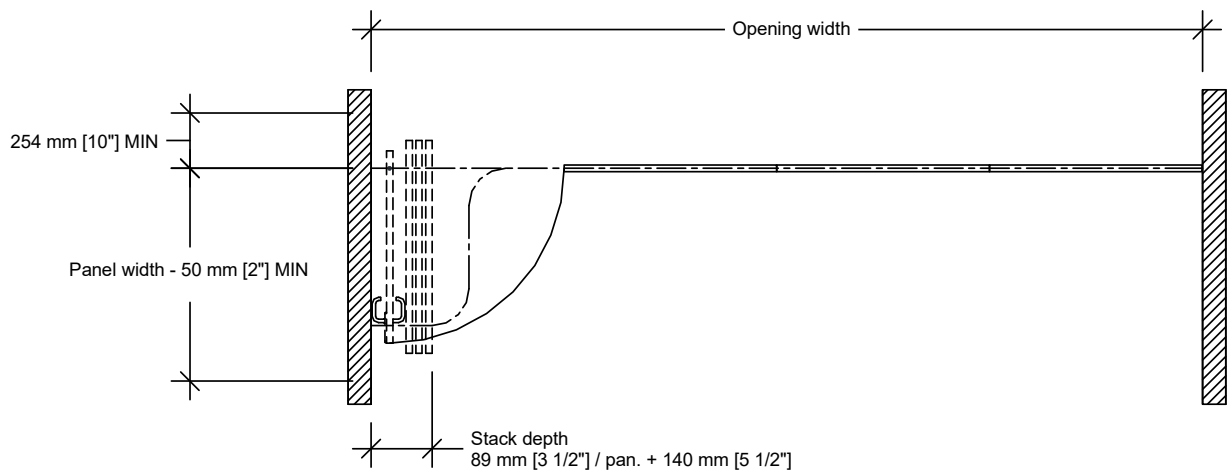

Wall to wall Side Stack – pivot door